

**Wymiary charakterystyczne
pojedynczego modułu**

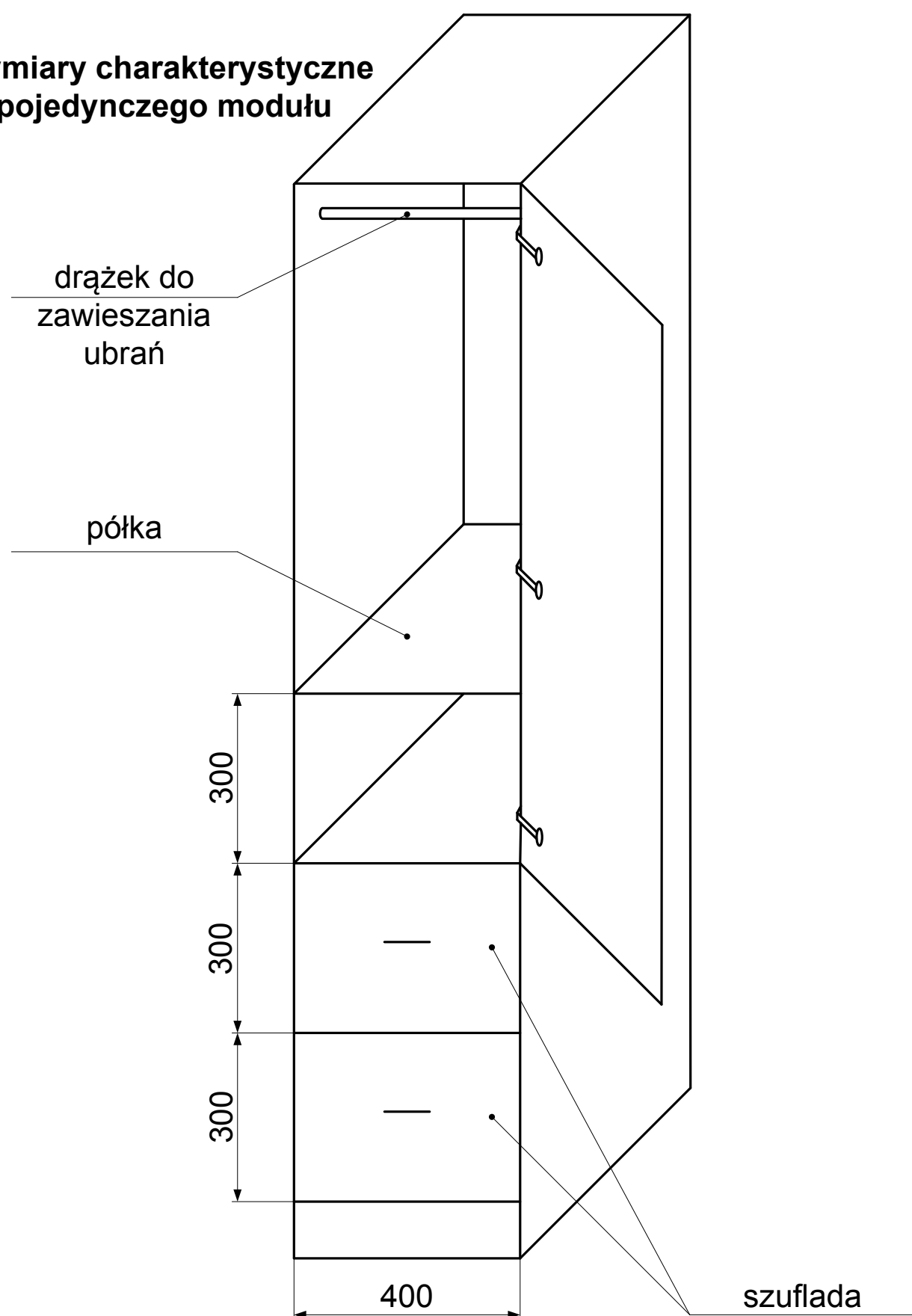

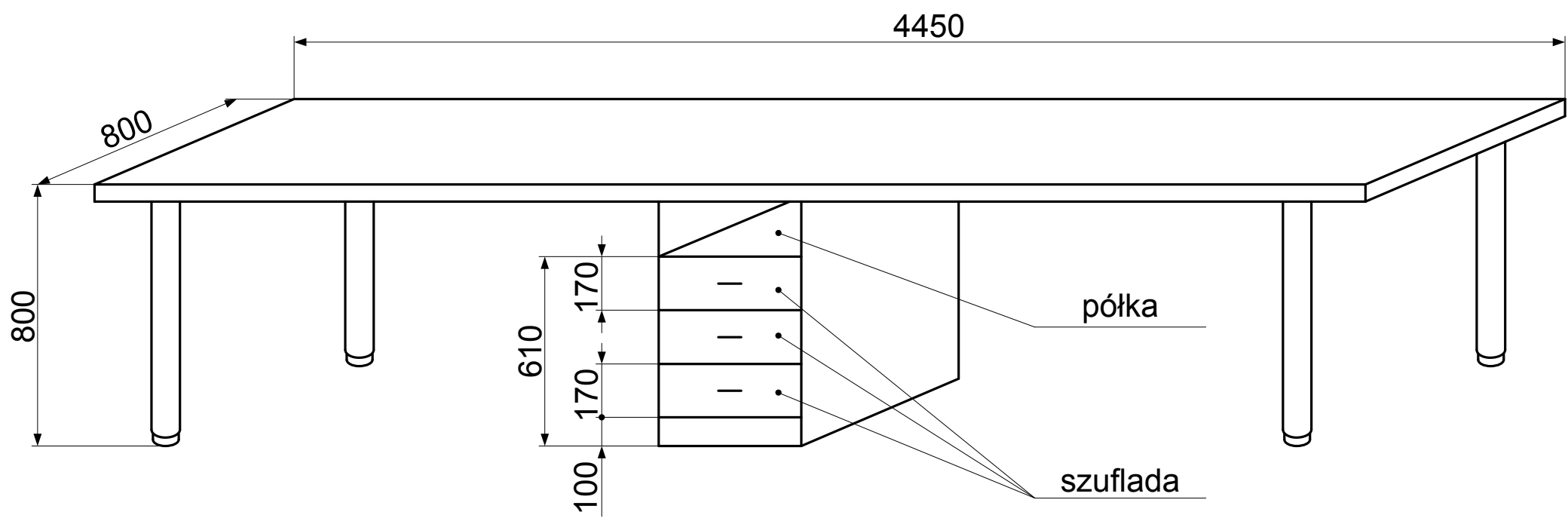

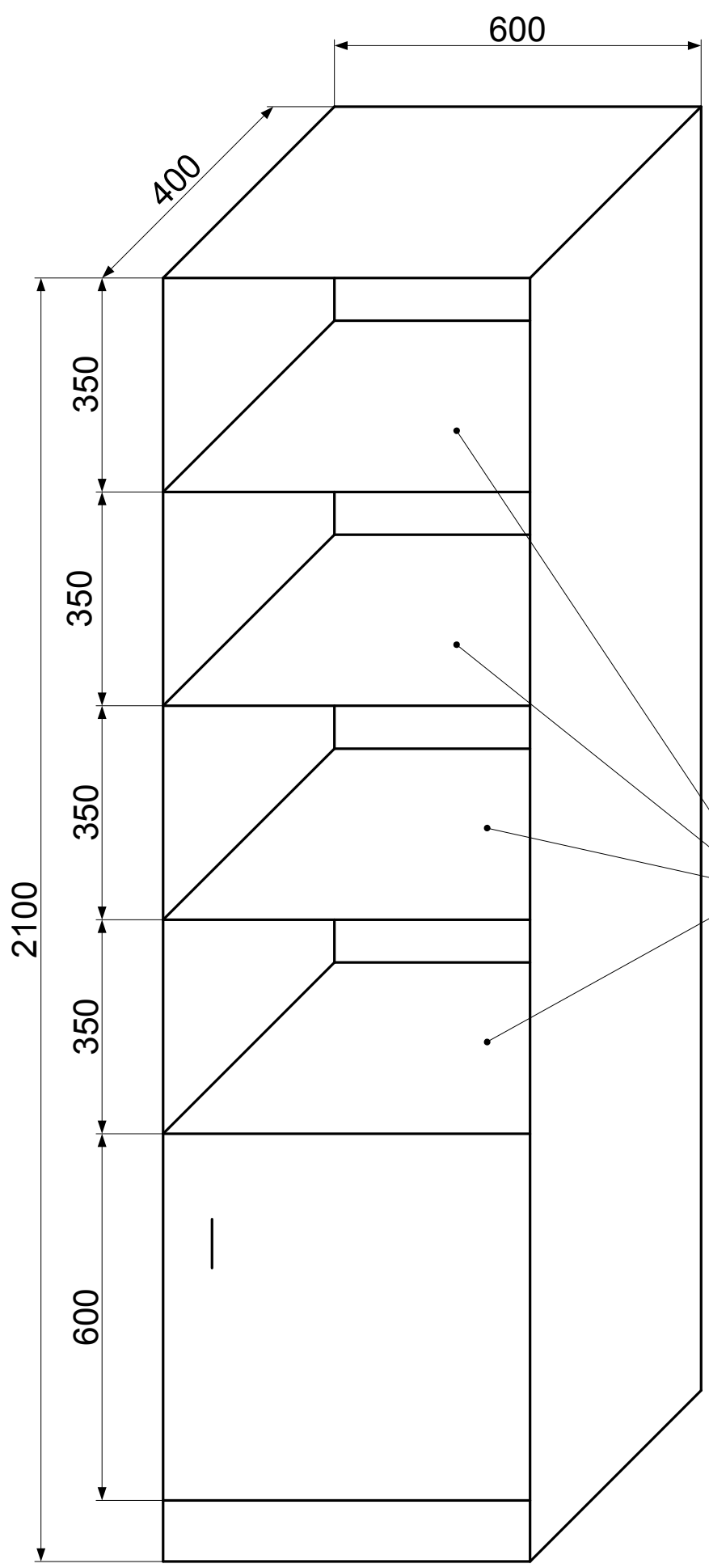

Szafa po otwarciu drzwiczek

półka

300

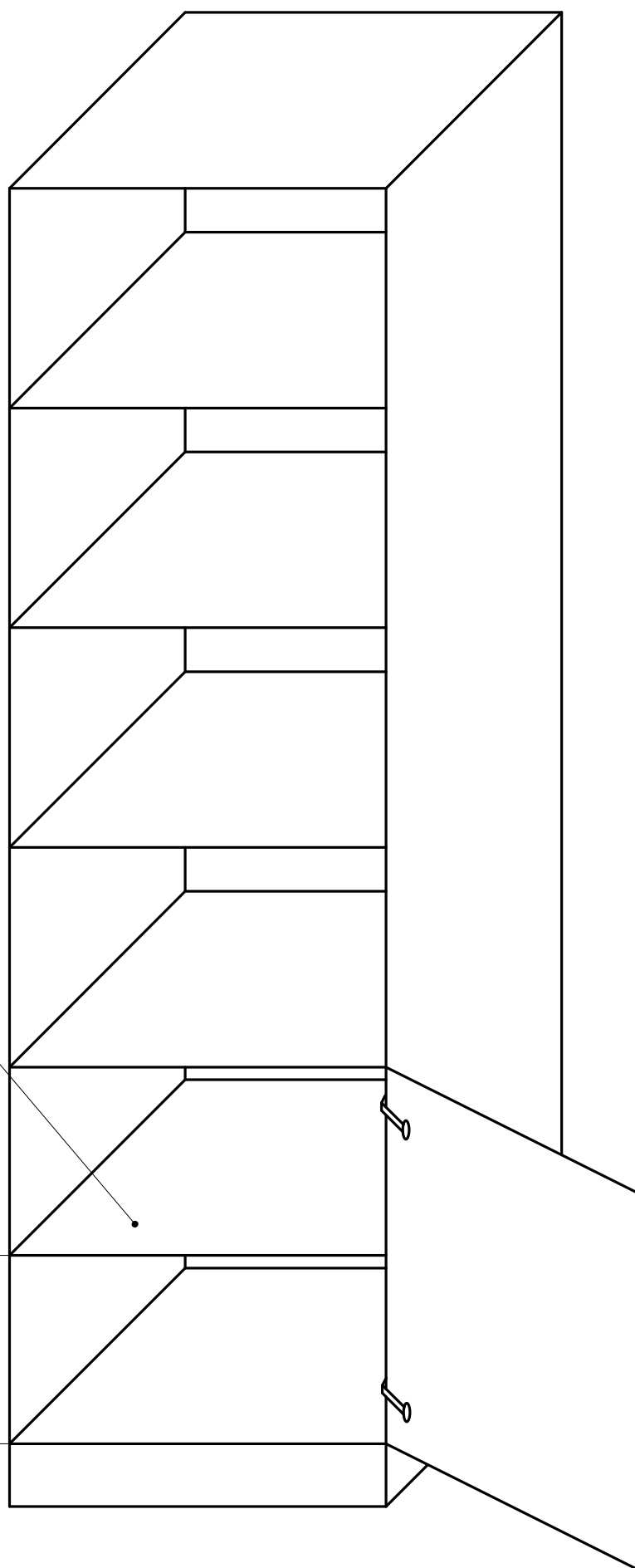

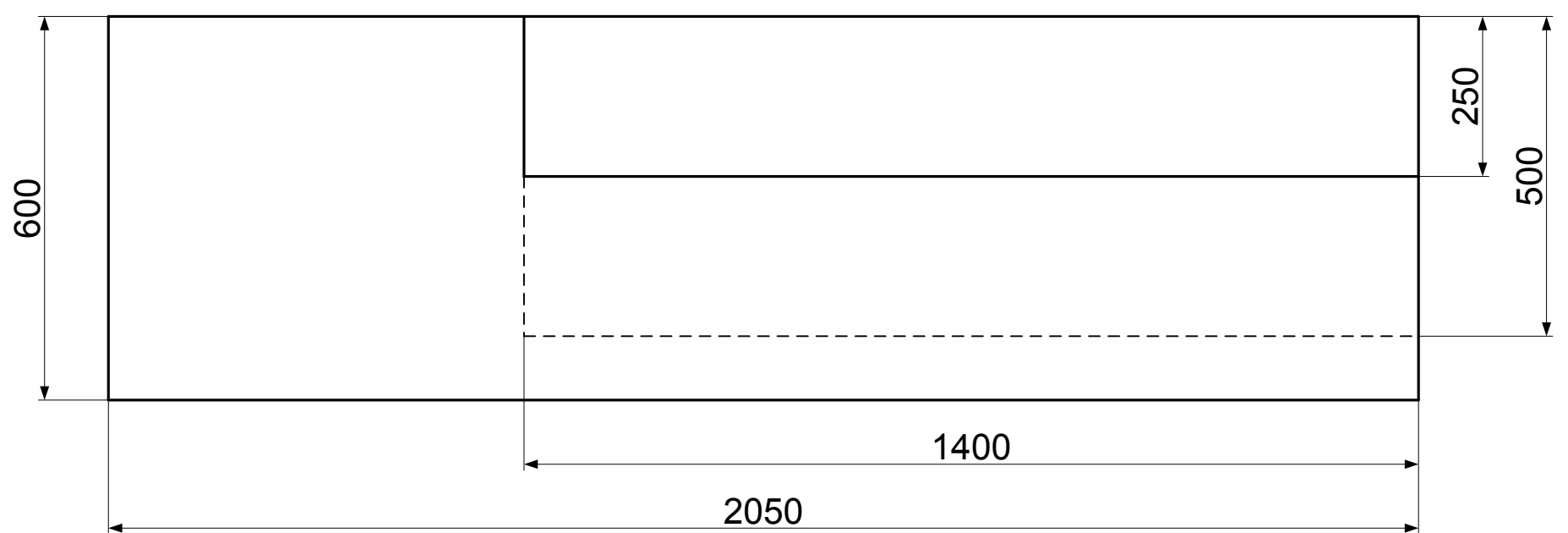
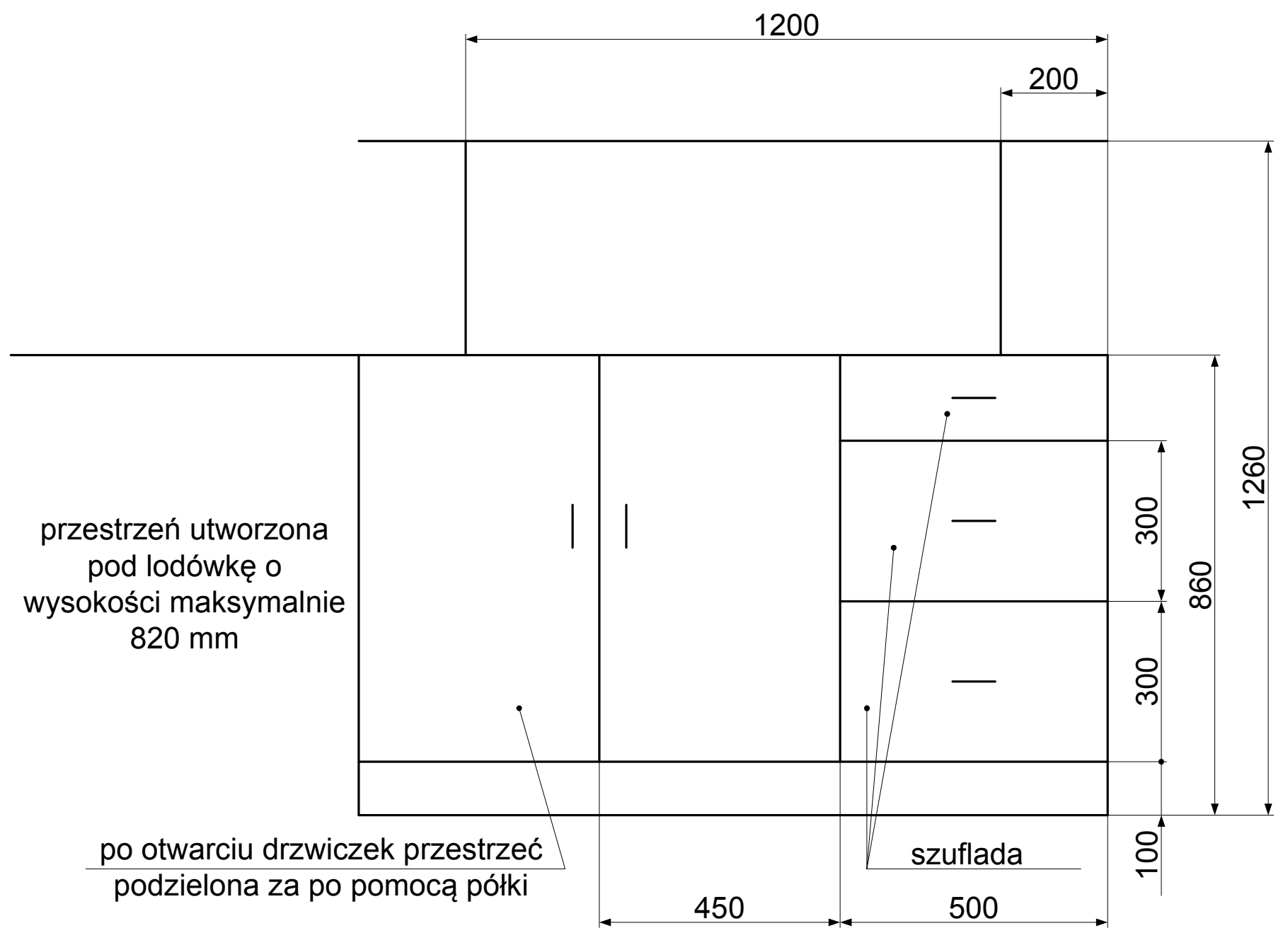

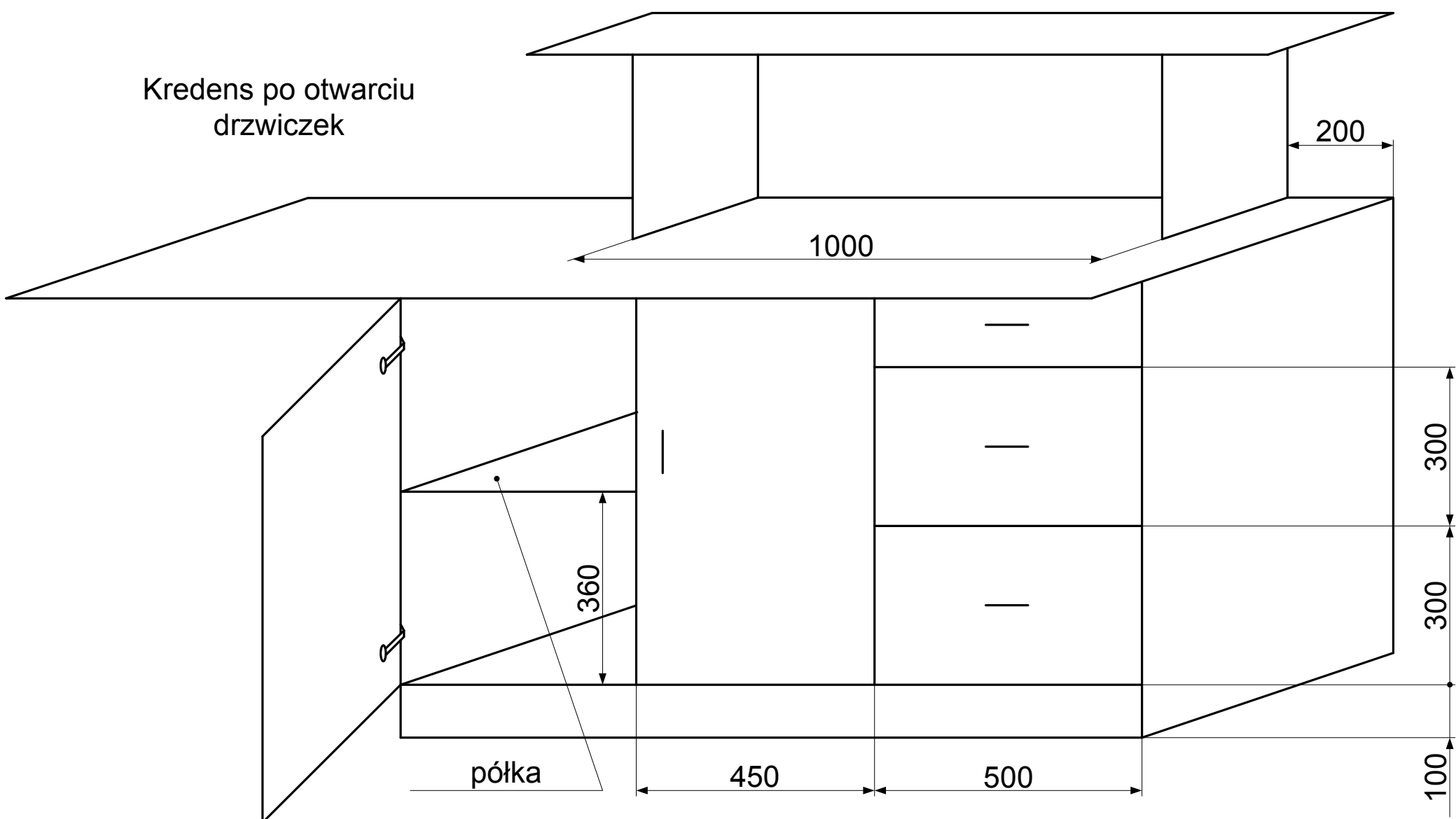
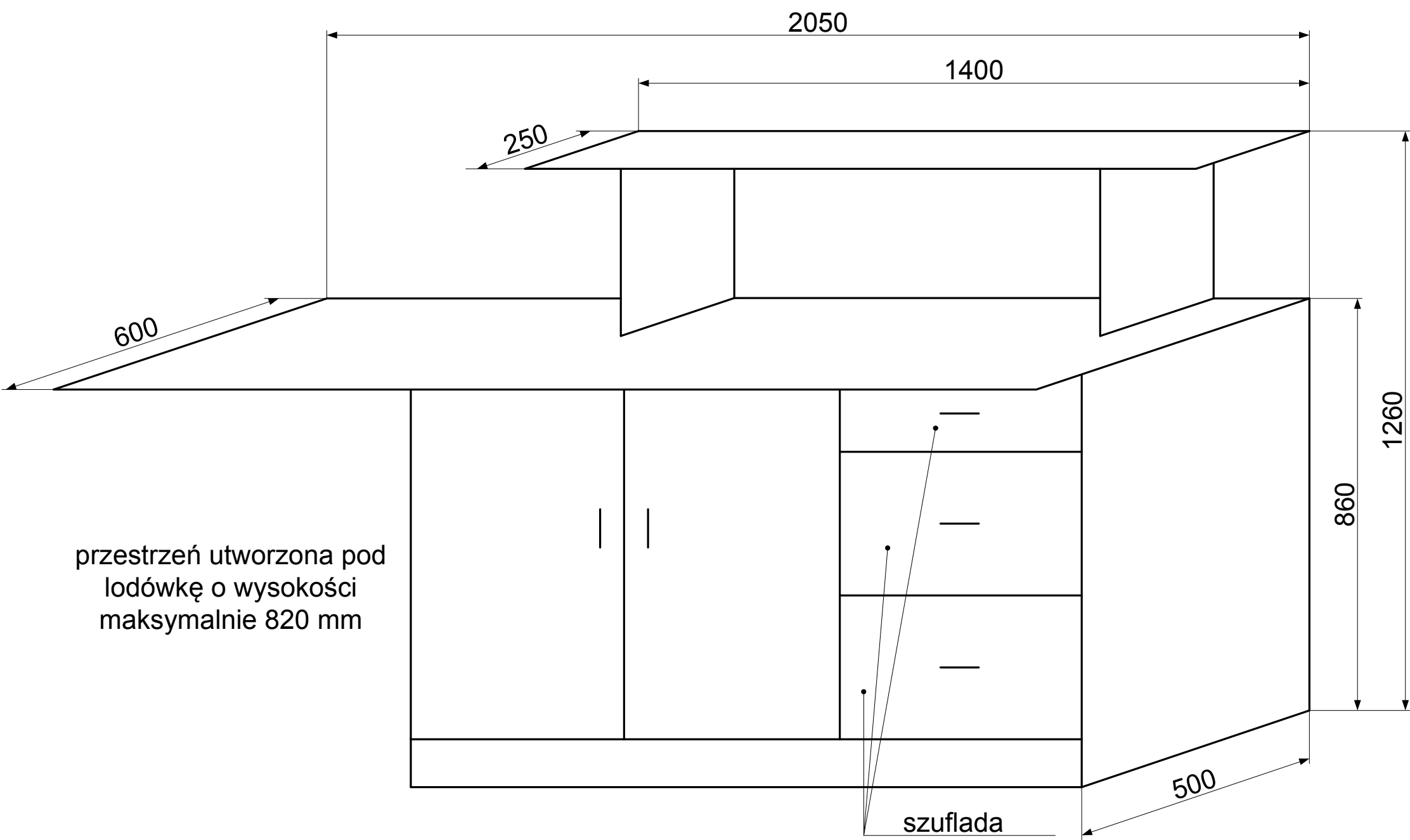

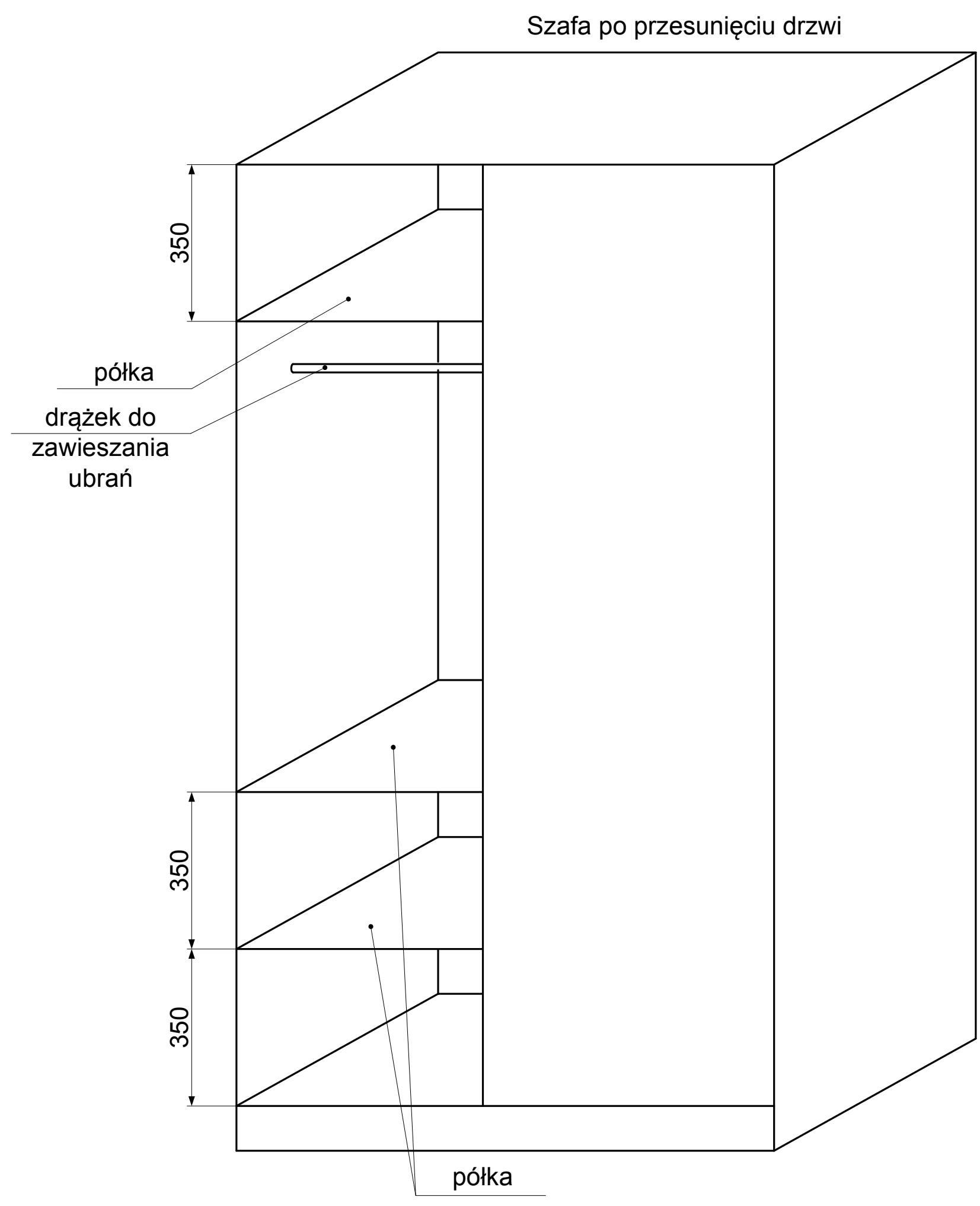
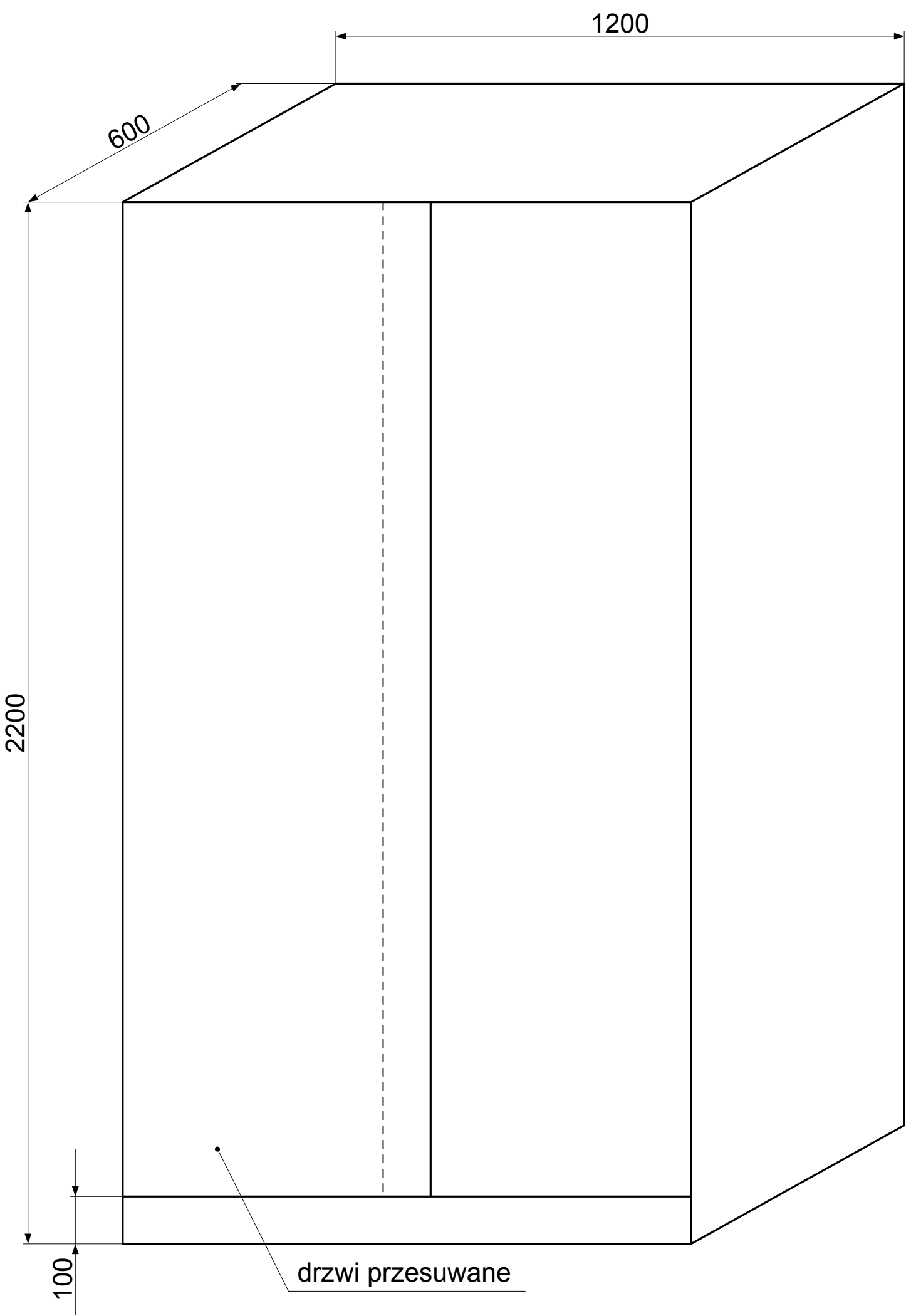

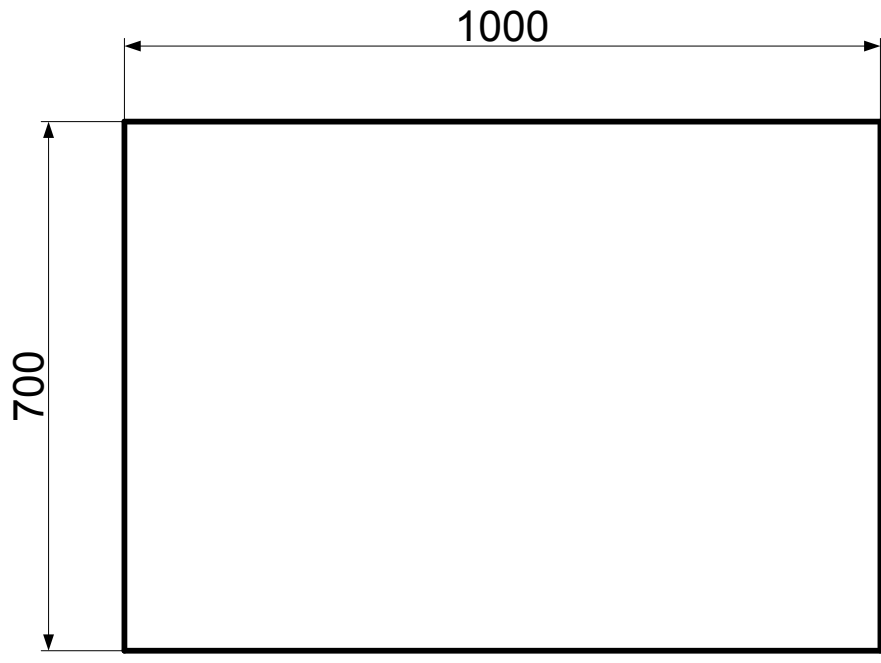
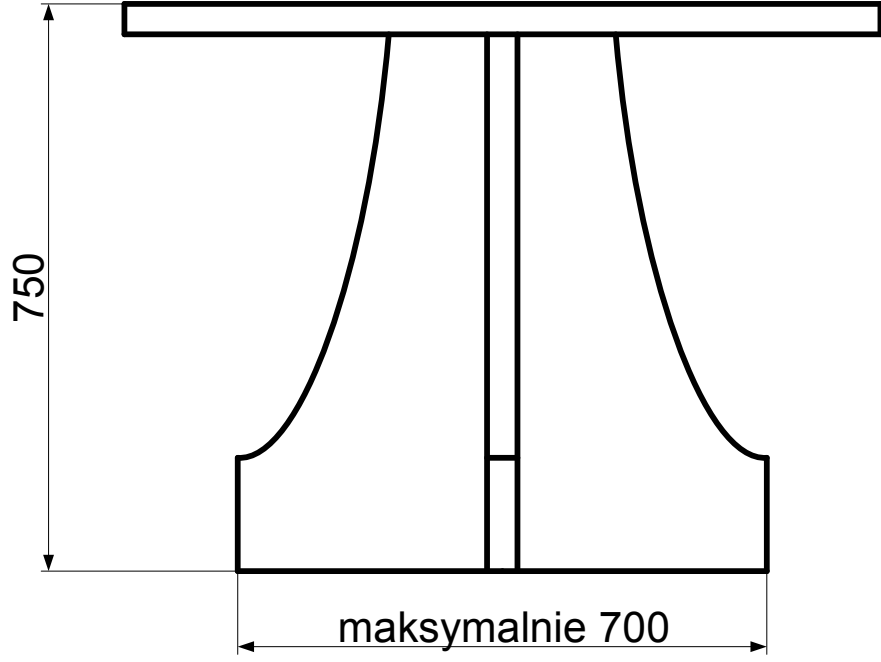

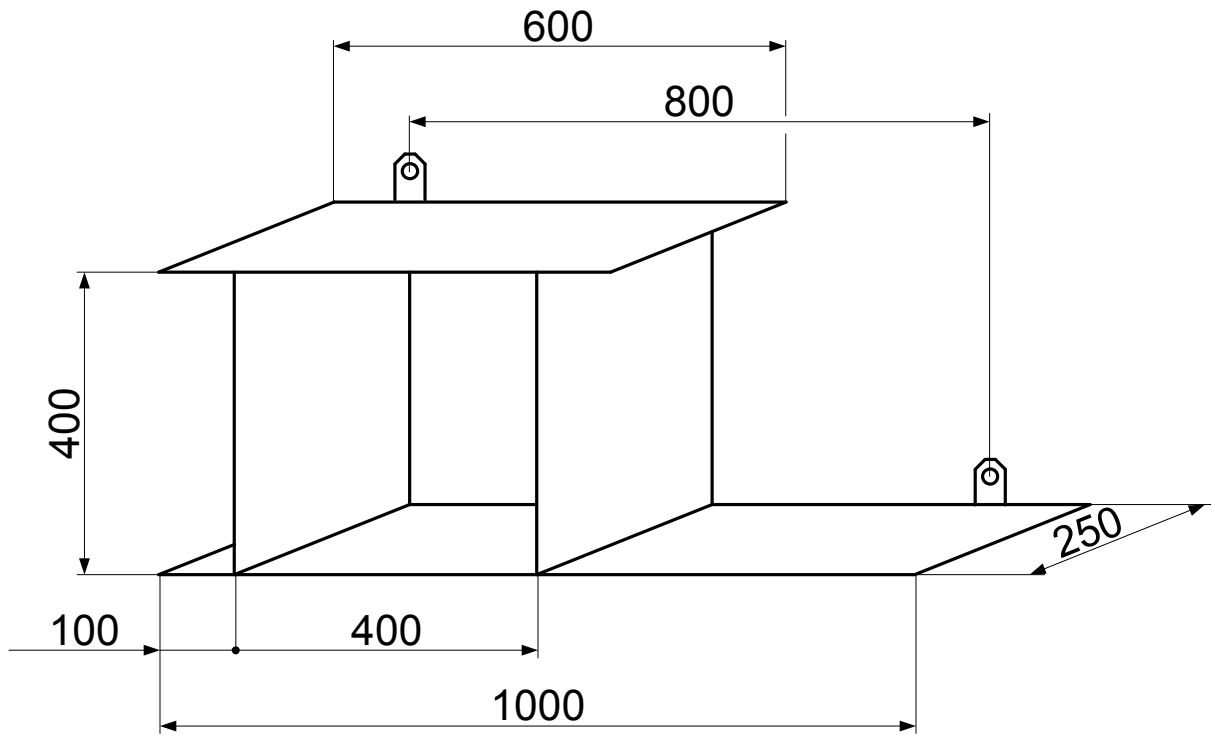

Zestaw mebli na wymiar dla nauczycieli WF

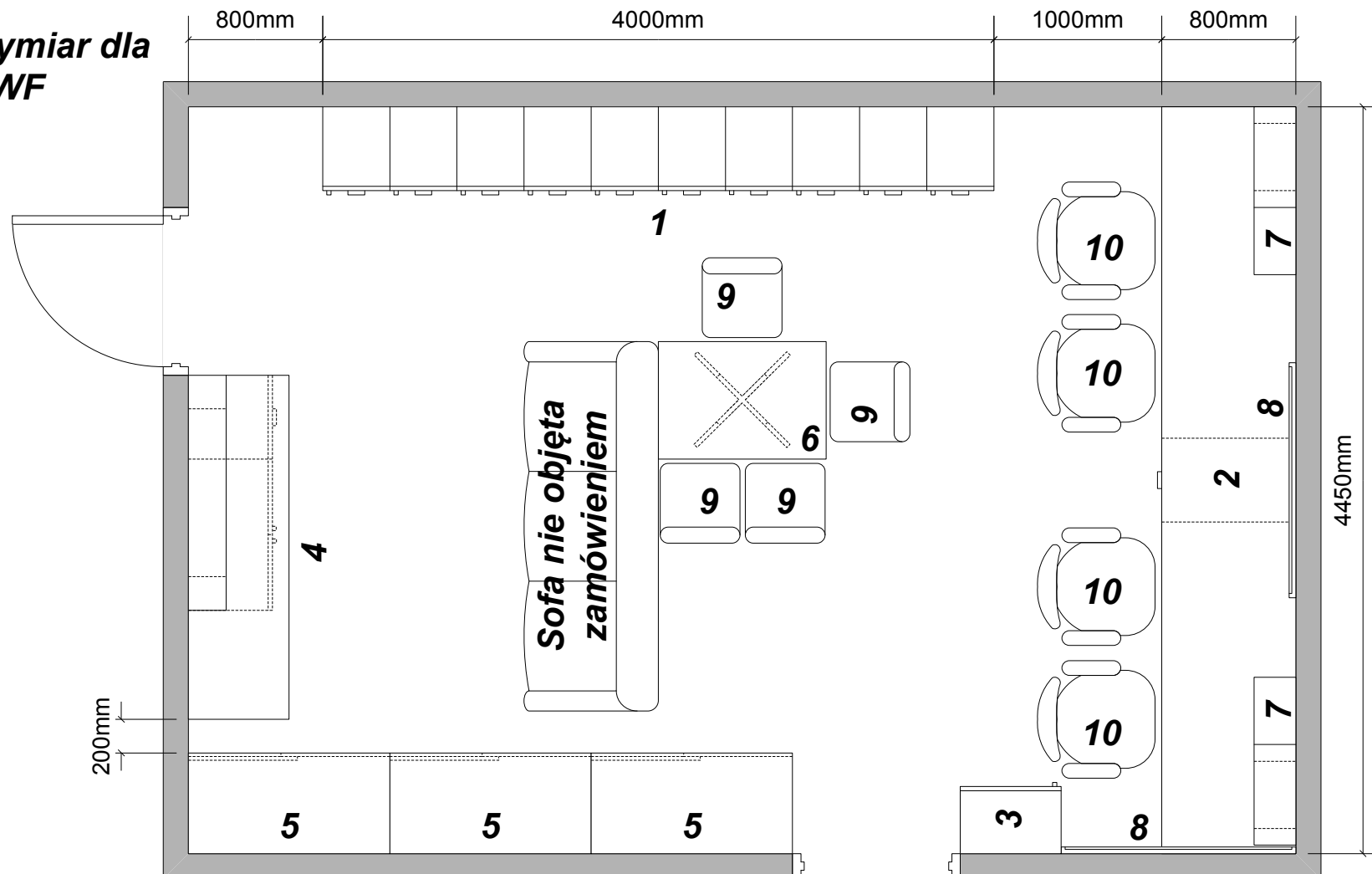

L.p.	Nazwa	Skrócona charakterystyka i wymiary gabarytowe w mm	Ilość
1	Szafa nauczycielska	Szafa 4000x1900x500	1
2	Stanowisko komputerowe	Stół 4450x800x800	1
3	Szafa na dokumenty	Szafa 600x2100x400	1
4	Kredens	Kredens z nastawką 2050x1260x600	1
5	Szafa z drzwiami przesuwanymi	Szafa 1200x2200x600	3
6	Stół na nodze centralnej (krzyżowej)	Stół 1000x750x700	1
7	Półka wieszana	Półka 1000x400x250	2
8	Tablica	Tablica korkowa 1400x800	2
9	Krzeseło tapicerowane	Krzeseło 440÷460x960÷1000x420÷470	4
10	Fotel komputerowy/biurowy	Fotel 680÷730x1080÷1170x680÷730	4